

ITER Towards the Construction

Y. Shimomura

for the ITER International and Participant Teams

- **Technical Preparations for Construction**
- **Organisational Preparations for Construction**
- **ITER as a Vehicle for Programme Integration**
- **Negotiations Status**
- **Conclusions**

**The 20th Fusion Energy Conference
Vilamoura, 2004-11-1**

Technical Preparations for an Efficient Start

- Prepare licensing application - close dialogue with potential regulators.
- Establish technical specifications for long-lead items and further development of design.
- Develop/implement management tools.
- Enhance scientific and technical activities in the Participants.

(Garching, Naka)



Detailed Design Has Been Developed

Central Solenoid

Nb₃Sn, 6 modules

Poloidal Field Coil

Nb-Ti, 6

Toroidal Field Coil

Nb₃Sn, 18, wedged

Blanket Module

440 modules

Port Plug

heating/current drive
test blankets
limiters/RH
diagnostics

Divertor

54 cassettes

Torus Cryopump

8 units

Vacuum Vessel

9 sectors

Cryostat

24 m high x 28 m dia.

Fusion Power: 500 MW

Plasma Volume: 840 m³

Plasma Current: 15 MA

Typical Density: 10²⁰ m⁻³

Typical Temperature: 20 keV

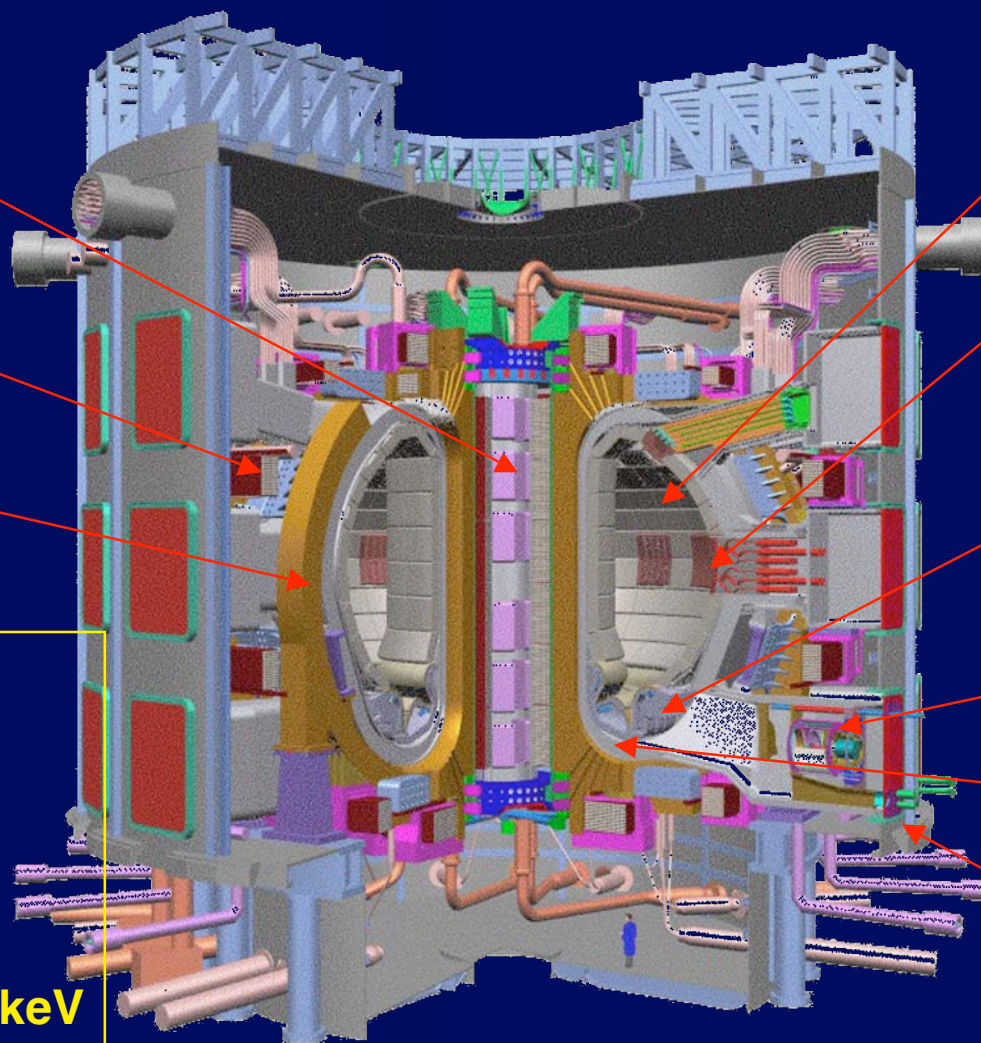

ITER Design Supported by Technology R&D

Completed 7 Large R&D by July 2001.

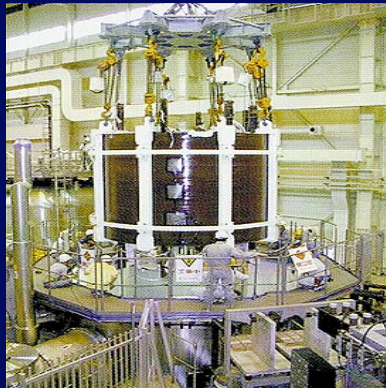

CENTRAL SOLENOID MODEL COIL

Radius 3.5 m
Height 2.8m
 $B_{max} = 13$ T
0.6 T/sec

VACUUM VESSEL SECTOR

Double-Wall,
 ± 5 mm



REMOTE MAINTENANCE OF DIVERTOR CASSETTE

Attachment Tolerance ± 2 mm



DIVERTOR CASSETTE 20 MW/m²

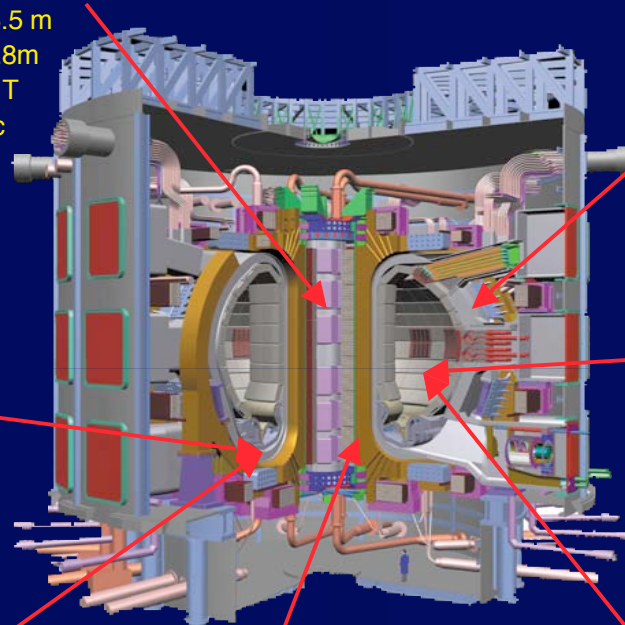
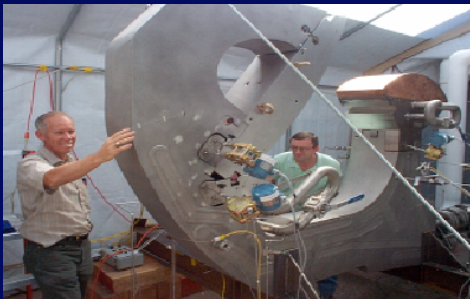

BLANKET MODULE

HIP Joining Tech
1.6 m x 0.93 m x
0.35 m



REMOTE MAINTENANCE OF BLANKET

4 tonne
 ± 0.25 mm

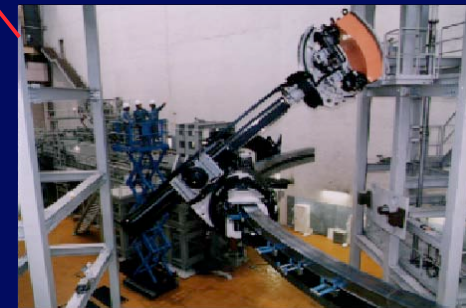

TOROIDAL FIELD MODEL COIL

Height 4 m
Width 3 m
 $B_{max} = 7.8$ T



ITER

Further Design Development

- **Magnets**
 - increased critical current (from ~6 to ~800 A/mm²)
 - use of stainless steel jacketing in all conductors
 - outer intercoil structure uses friction joint of welded plates
- **Vessel/Blanket**
 - support arrangement simplified
 - nine lower ports
 - blanket module has FW supported from welded central leg
 - improved module arrangement around NB ports
 - improved interlocking of thermal shield
- **Building/Services**
 - introduction of port cells
 - relocate gallery equipment - access, e/m loads
 - incorporate seismic isolation for both potential sites
 - improve site layout

Seismic Isolation for Both Potential Sites

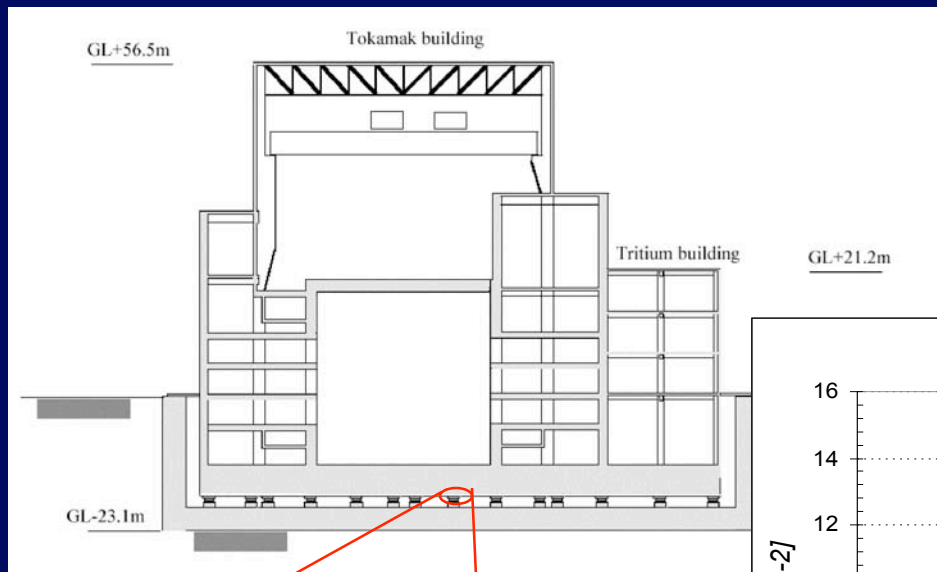

Simplify supporting structure and building

Example: Rokkasho

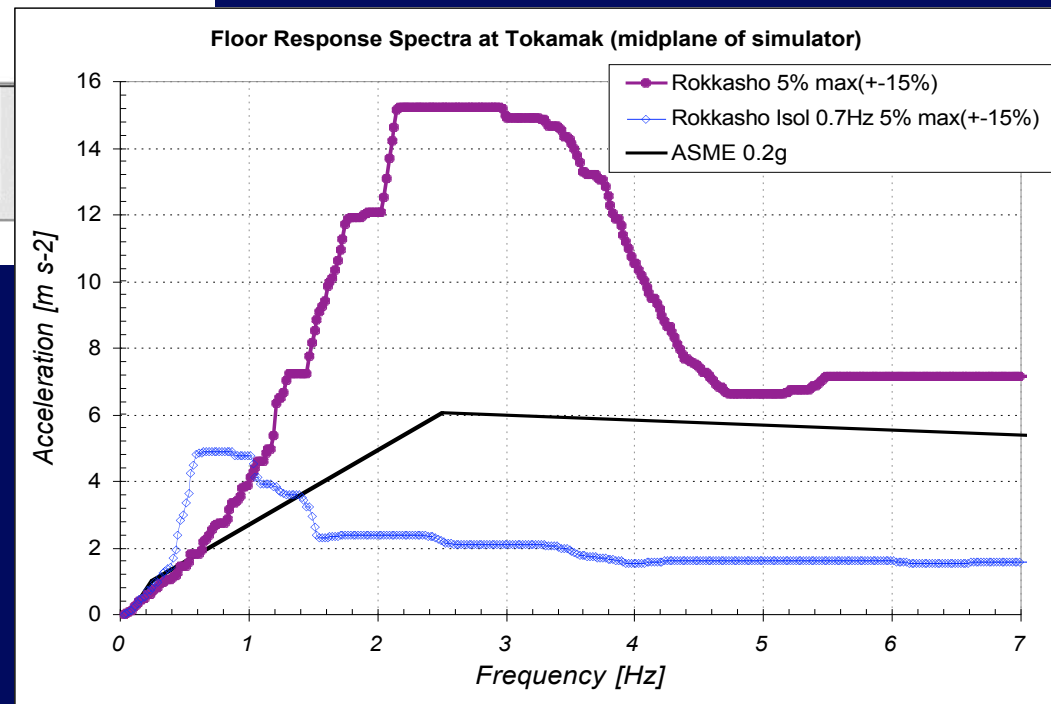
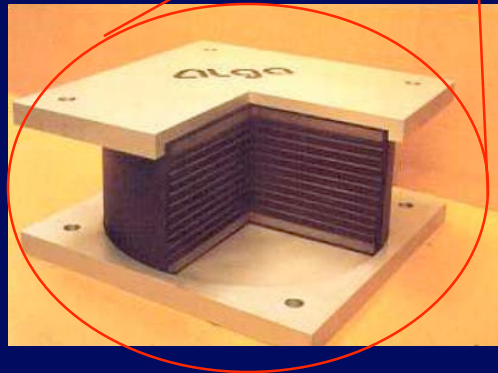

Port Cell: Second Containment Barrier

- **Second containment barrier moved to port cell door.**
- **Simplify structures attached to ports.**
- **Reduced number of operations in irradiated areas.**

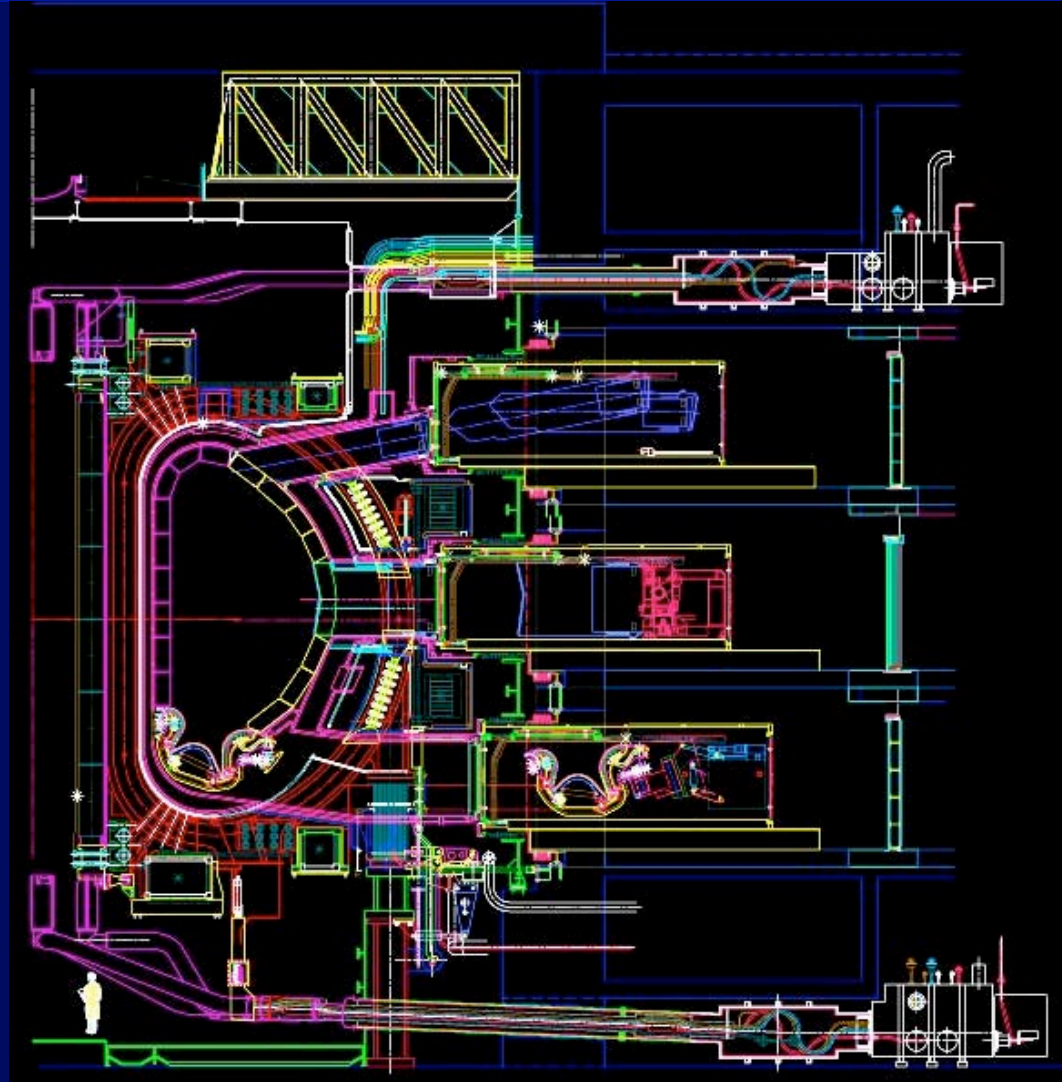

Independent Vacuum Vessel Support System

- Separation between safety component, vacuum vessel, from non safety one, TF coils.
- Simplification of assembly and thermal shield.
- Possible to adjust the VV after welding of the sectors.

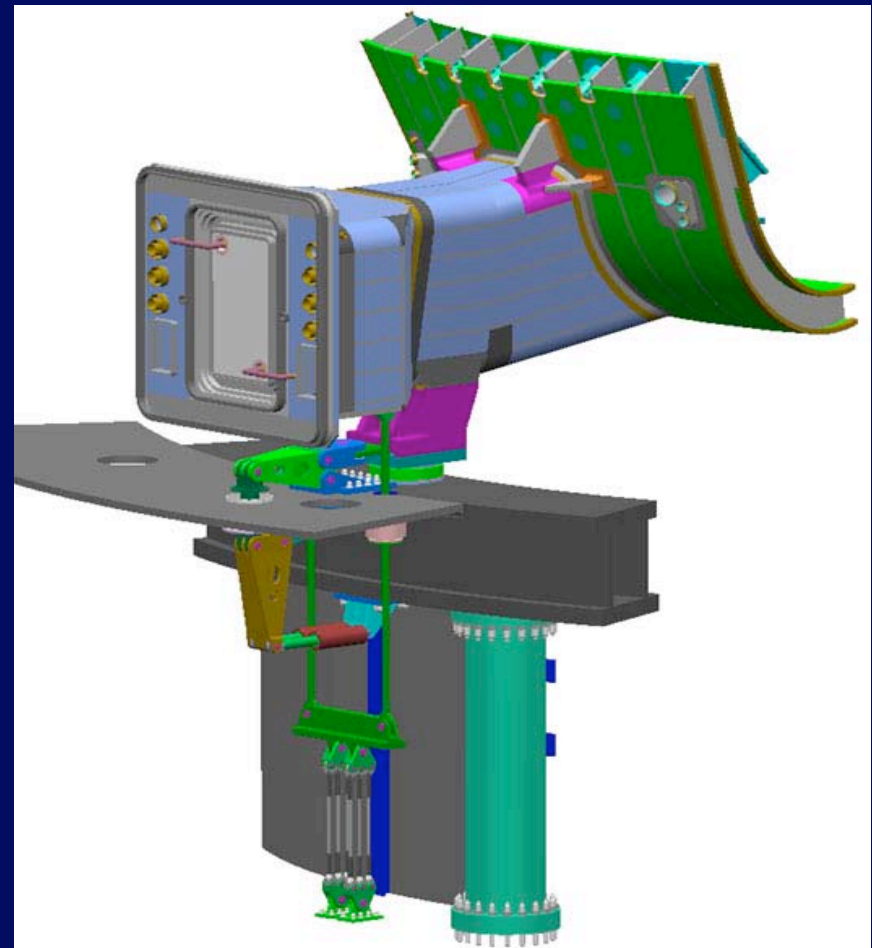

Replaceable First Wall Panel

Minimizing Waste

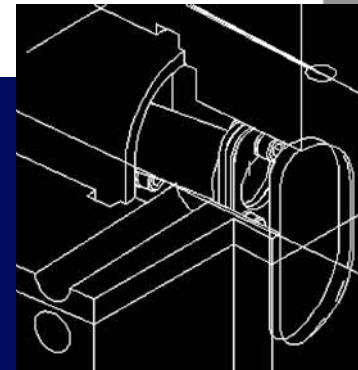
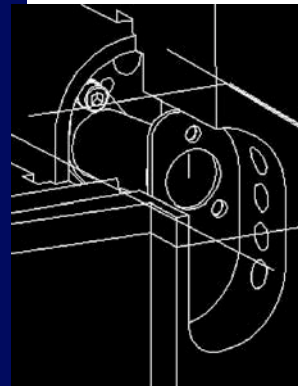
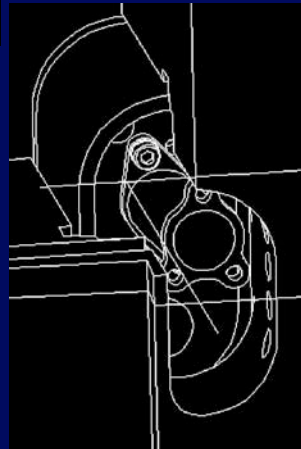
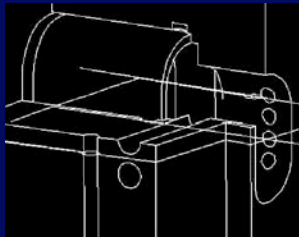
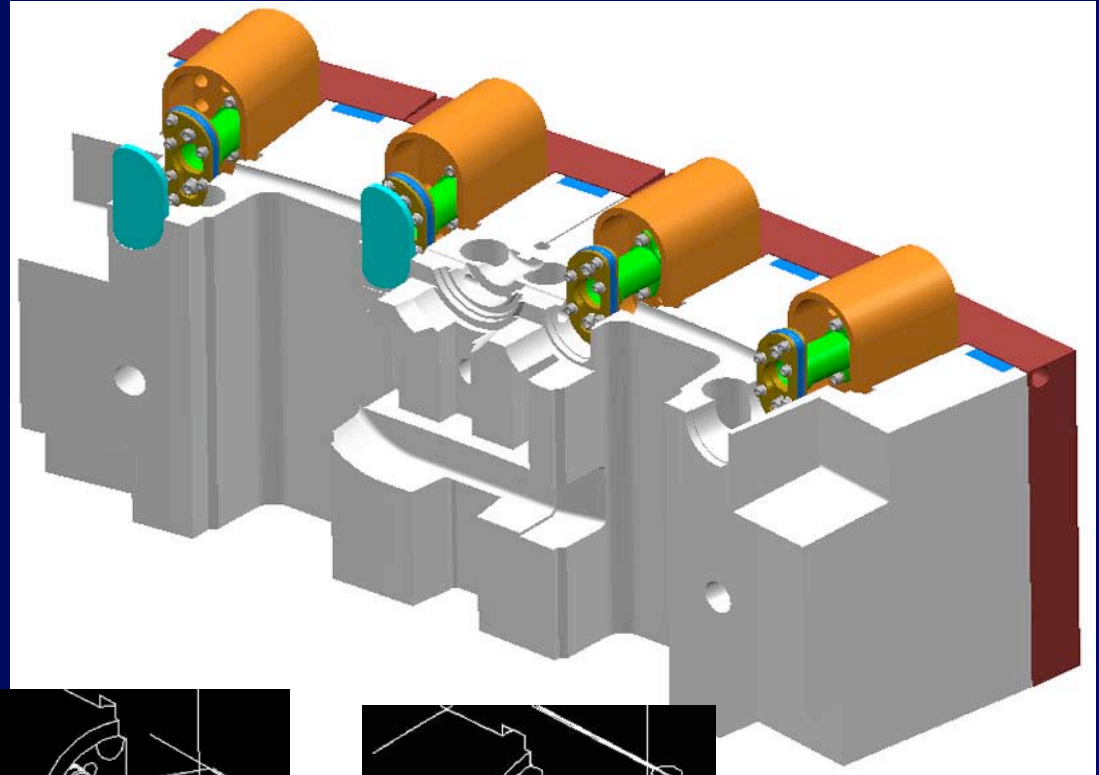
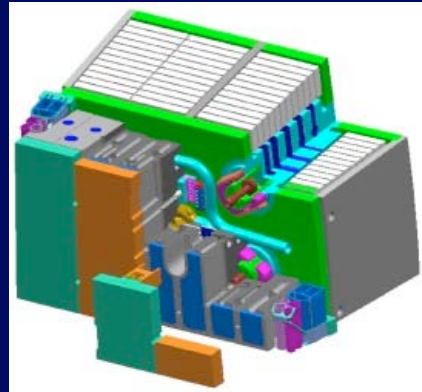
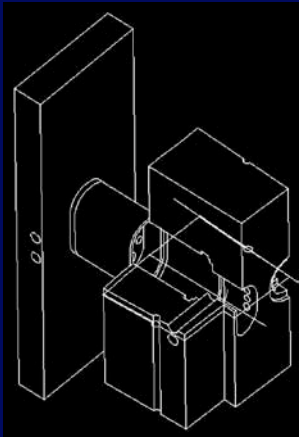

Construction Schedule

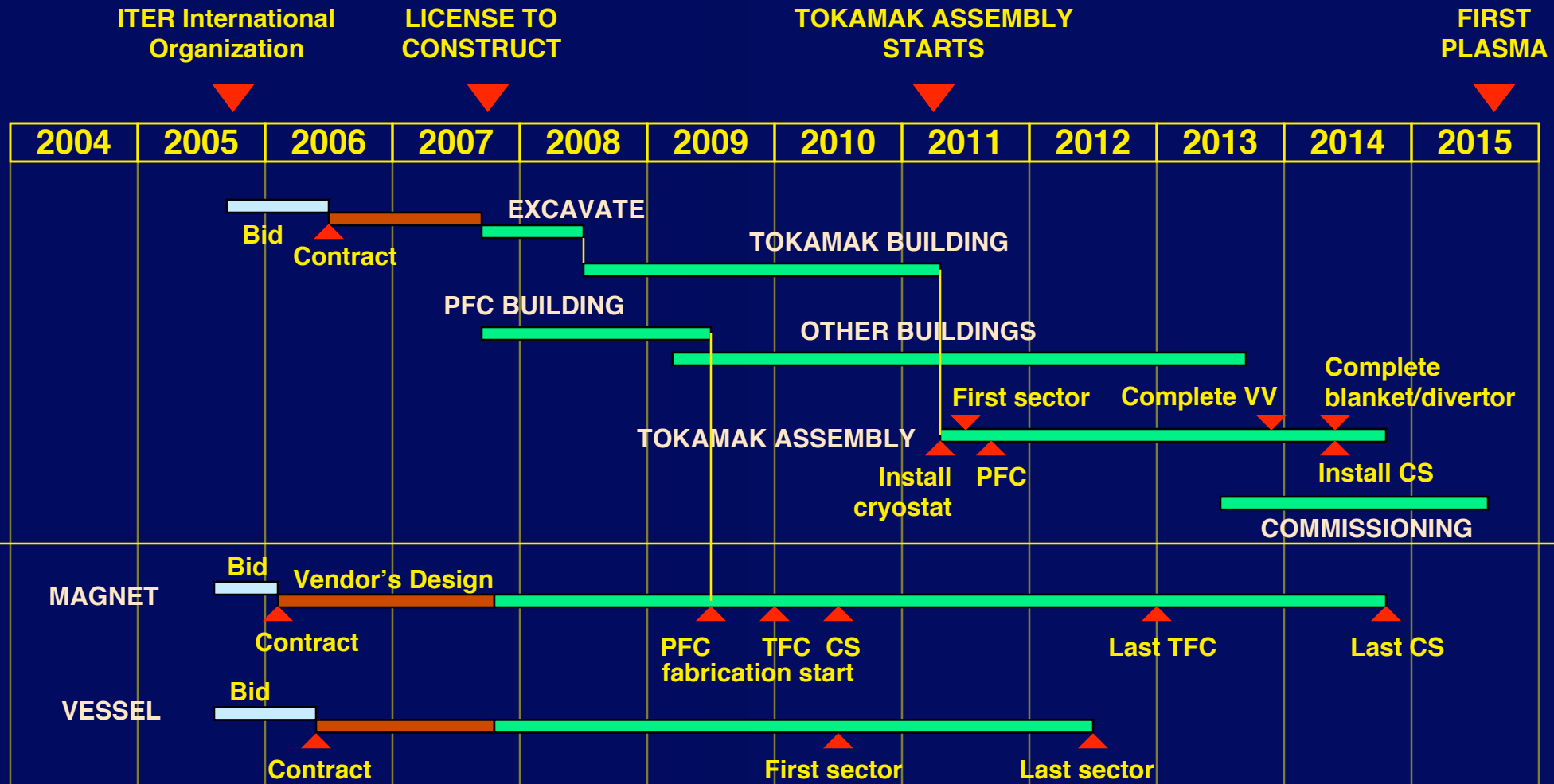

Development of Procurement Specifications

- **Detailed technical specifications for long lead items:**
 - **Magnets:**
 - » strand and conductor
 - » PF and TF coils
 - **Vessel:**
 - » main vessel and ports
 - » blanket coolant manifolds
 - **Buildings:**
 - » tokamak complex
 - » cryogenic halls used for PF coil winding
 - » service tunnels
 - Task Forces established with PT/IT membership to complete work in necessary detail and with industrial realism – only partly successful due to lack of site decision.
- **Manufacturing R&D**
 - Develop/confirm manufacturing methods and QA procedure
 - » magnet, vessel, blankets, etc.

Organisational Preparations

- **Risk Management**
- **Configuration Management**
- **Document Management**

Risk Management - The Problem

- **90% of items will be provided in kind from the 6 Parties and sharing amongst them has not been optimised especially to minimise risk.**
- **Such an experiment cannot be built without some changes during construction which may affect suppliers in several Parties.**
- **Unlike normal centrally-funded projects, any margins actually realised will not be seen by the project for items provided in kind.**
- **The project therefore has no “cushion” for overcost items or failed/delayed deliveries.**
- **Very long time scale of the project and lack of experts.**

Large Number of Specific Very High Quality Components

500 t of Nb₃Sn, 2000 first wall panels and 2000 divertor elements

- **Risks:**
 - Too low production/acceptance rate.
 - Too high costs.
- **Minimisation of risks:**
 - R&D including QA.
 - Qualification of potential vendors before call for tender.
 - (Nb₃Sn strand: Trial production and tests ongoing with 15 vendors)
 - (First wall panel: Trial production and tests will start soon)
 - Fixed price contracts with multiple vendors with demonstrated capability.
 - Staged production and “holding” of cash contingency.
- **Mitigation of consequences:**
 - Transfer of remaining production to other vendors demonstrating adequate production quality. A solution is needed for funds transfer from the defaulting to the compensating Party.

Large and Complex Tokamak Core Components

- **Risks:**
 - Unacceptable delays.
 - Inability to maintain quality in series production.
 - Design changes.
 - Too high costs.
- **Minimisation of risks:**
 - R&D (7 Large Projects), detailed fabrication and QA (in progress).
 - Very good preparation esp. specification and planning (underway).
 - Firm and fixed price contracts for reasonably large packages of work.
 - Prime- - subcontractor relationship between multiple Parties' vendors.
 - Very good direct relationship between ITER International Organisation and vendors.
- **Mitigation of consequences:**
 - ITER International Organisation must minimise cost impact of changes.
 - ITER International Organisation must seek compensating cost savings within the contract, or with other contracts.
 - Access to a general reserve fund as a last resort.

Complex Organization and Lack of Experts

- **Risks**

- Lack of specialists.
- Lack of technical continuity due to long time scale.
- Inefficiency of complex international structure.

ITER Organisation (during construction)

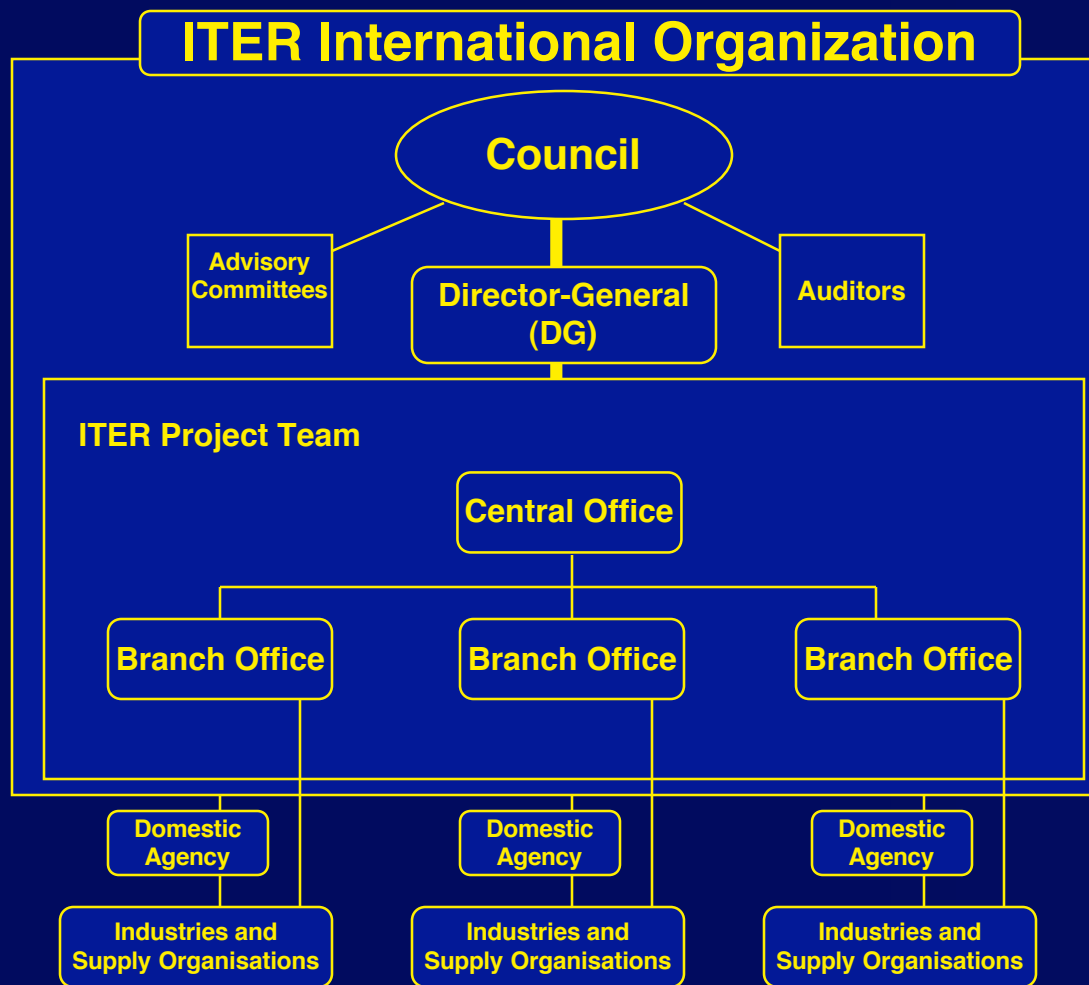

— Staff regulations, DG power in choosing and rewarding staff, and Parties ability to provide good staff, are vital to project success:

- to attract the right staff at the right time.
- to keep them as long as they are needed by the project.

— Minimize inefficiencies and duplication of roles among ITER International Organization, Domestic Agencies and Suppliers.

Simple Relation between ITER Organization (via Branch Office) & Supplier

Parties' Agencies must play a supporting rather than a leading role.

•Component procured by Party A



For a specific component, a prime contractor could be an institute or an association, which will have to implement QA/QC system. (pellet injector, diagnostics, etc.)

•Component shared by Party A and Party B



•Extremely inefficient arrangement for a core component shared by multi Parties.



Risk Management - Implications

- **The future DG needs to have sufficient tools and flexibility.**
- **Inefficiencies and duplication of roles among Project Team and Domestic Agencies must be minimized.**
- **Project Team needs to be strong enough to be present in the factory so as to recognize and limit such occurrences.**
- **Parties must safeguard their own and the Project interests by not making stage payments without Project Team concurrence.**
- **The Parties may have to jointly compensate a manufacturing Party for consequent costs exceeding those that Party gains from other procurements. They may need a contingency for this.**
- **The project must furthermore implement systems which will improve its own efficiency and reduce the risk of errors, e.g.:**
 - **Document Management**
 - **Configuration Management**

Configuration Management Procedures

- **Technical Coordination Meetings (TCM)**
 - Decides on change proposals (DCRs)
 - Organises and schedules supporting work and priorities
- **Design Change Requests (DCR)**
 - Document proposals for changes
- **Design Work Orders (DWO)**
 - Request CAD effort
- **Design Work Check (DWC)**
 - Process to check drawing office output
- **Design Integration/Drawing Office (DIDO) Meetings**
 - Reviews ongoing CAD progress, prioritises new CAD effort allocation, and schedules detailed design reviews

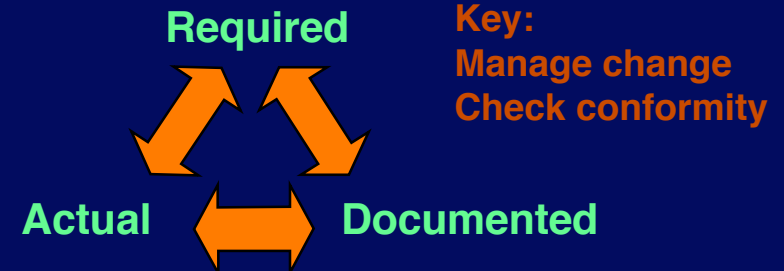

Improvement of Configuration Management Tools

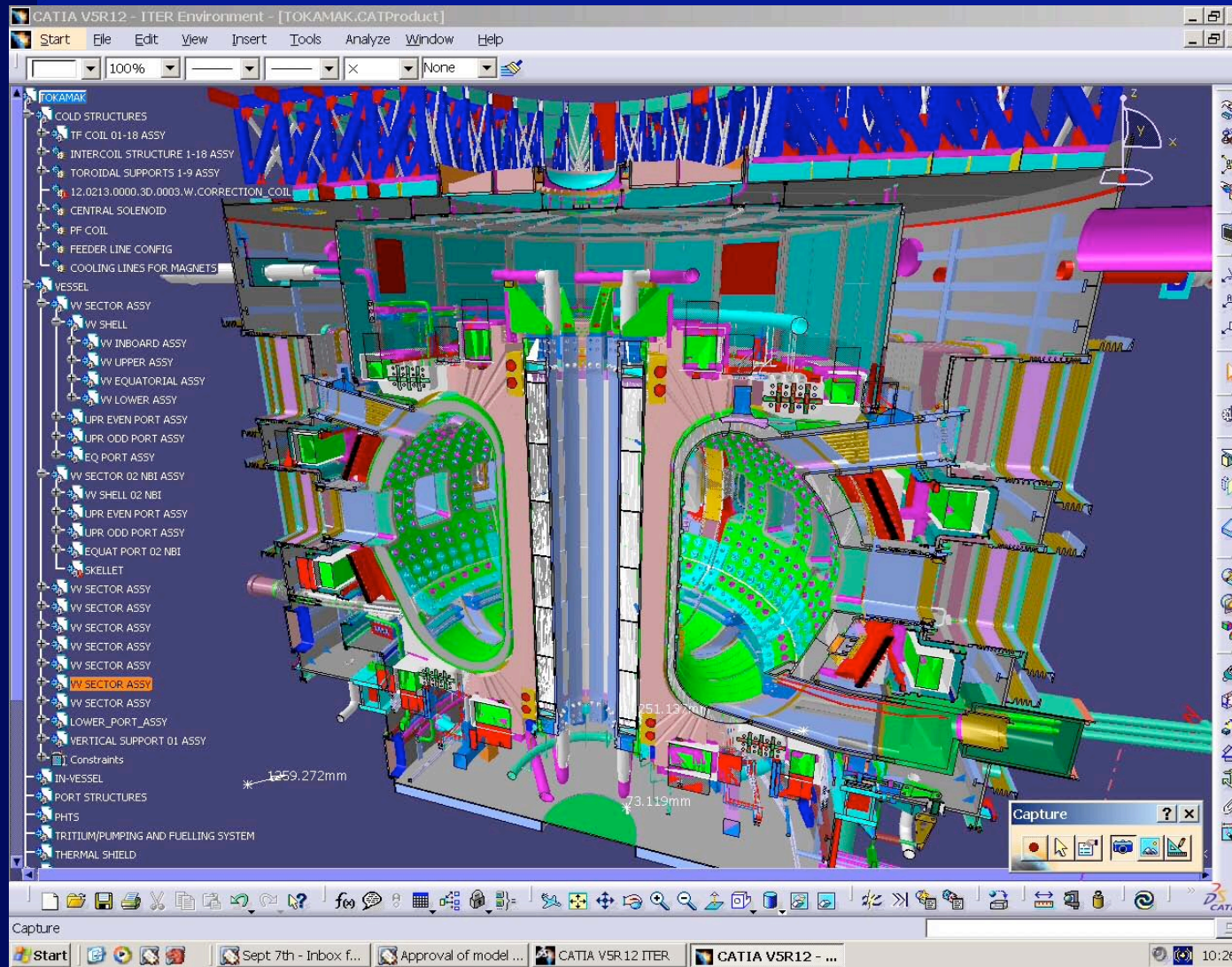

- Complexity, clash detection, utility routing, collaborative design with Participants, need better tools.
 - ITER needs “Virtual product data management” software for 3D digital mockup implemented in 2004.
 - Complete switch to CATIA V5 at end of 2004
- ITER**

Replacement of Document Management System

- **Features needed for ITER:**
 - tree/network navigation of linked documents,
 - approval workflow tracking,
 - document validity according to circumstances,
 - electronic signature,
 - worldwide access to authorised personnel.
 - good interface with CATIA V4 and V5;
 - full functionality from multiple platforms (XP, OSX, Linux, Unix);
 - access security and reliability;
- **Own system developed based on open source toolbox (ZOPE).**
- **Start of use in Oct. 2004.**

ITER as a Vehicle for Programme Integration

- **Diagnostics, Heating & Current Drive Systems and Test Blankets**
- **International Tokamak Physics Activities**
- **Remote Participation in Physics**
- **Broadening the Scope of the “Next Step”**

40 Different Diagnostic Systems

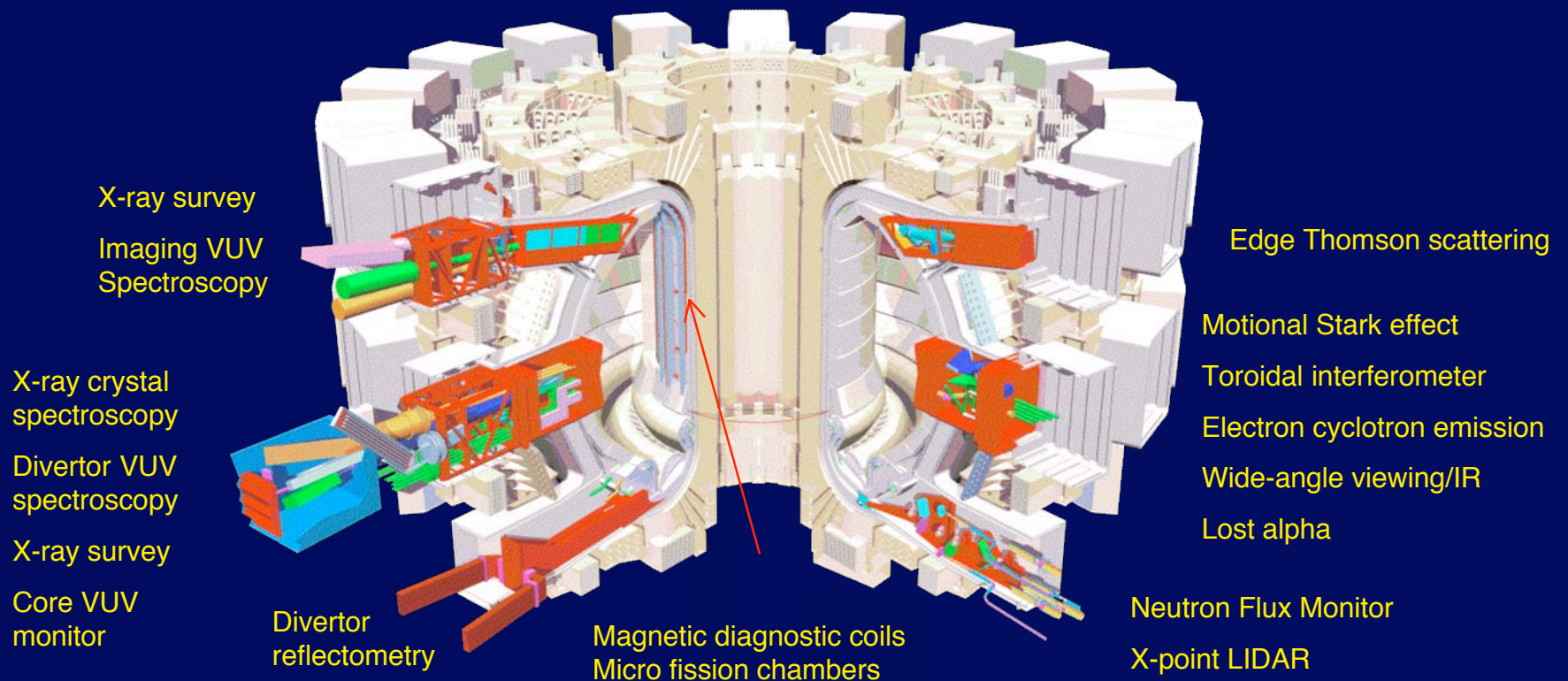

- **Significant effort in participating labs.**
 - Carry out necessary R&D
 - Finalise detailed design
 - Monitor procurement/implementation
- **QA/QC system must be implemented**

Flexible Heating and Current Drive System

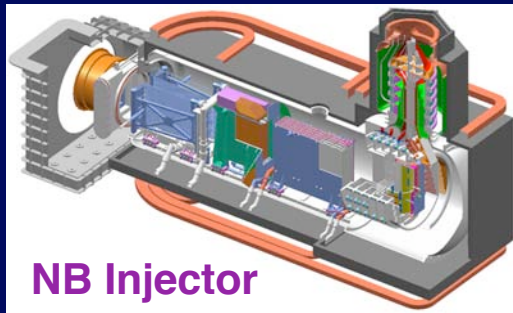

NB Injector

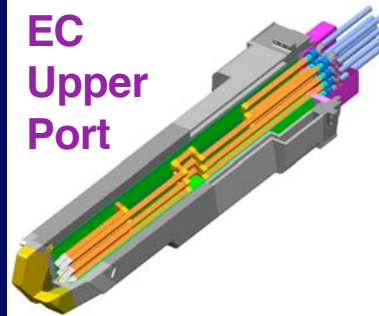

EC Upper Port

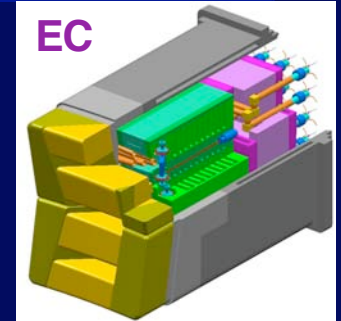

EC

	Startup		Scenario 1		Scenario 2		Scenario 3		Scenario 4	
	Power [MW]	Equat. ports	Power [MW]	Equat. ports	Power [MW]	Equat. ports	Power [MW]	Equat. ports	Power [MW]	Equat. ports
NB	33	2	33	2	50	3	50	3	50	3
IC	20	1	40	2	20	1	40	2	20	1
EC	20	1	40	1 ⁽¹⁾	40	1 ⁽¹⁾	40	1 ⁽¹⁾	20	0 ⁽¹⁾
LH	0	0	20	1	20	1	0	0	40	2
Total Installed	73	4	133	6	130	6	130	6	130	6

⁽¹⁾EC H&CD uses 3 upper ports for the power upgrade

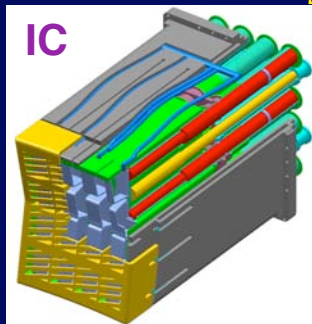

IC

11/3/04

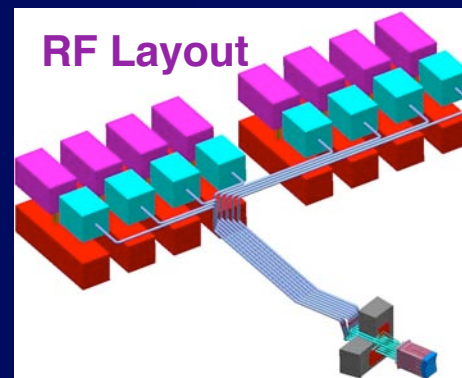

RF Layout

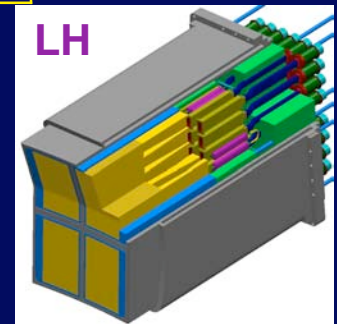

LH

ITER

Further Development of NB Required

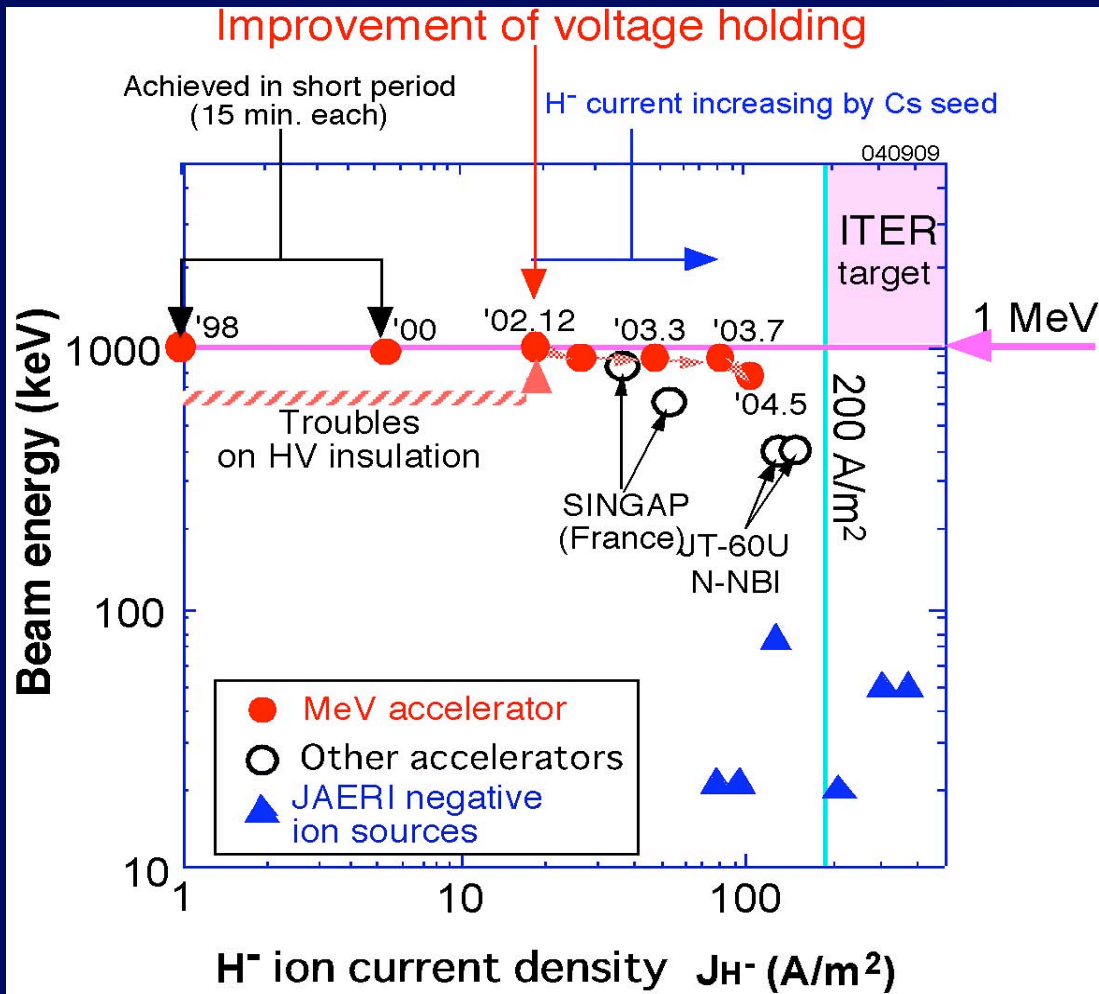

H⁻ ion current density increasing progressively, since improvement of the voltage holding in vacuum insulated accelerator.

Beam energy	Negative ion current	Negative ion current density
ITER		
1 MeV	40 A	200 A/m ²
(Achieved)		
0.4 MeV	20.4 A	150 A/m ²
0.9 MeV	0.11 A	80 A/m ²
0.8 MeV	0.14 A	102 A/m ²

- The R&D in progress to increase the negative ion current density up to the ITER requirement.
- Recently, the beam dump replaced to swirl tubes: CHF at 140 A/m², 1 MeV
- Power supply of the facility: ≤ 1A.

ECRF: Status of Gyrotron Development

Progress of Gyrotron R&D

- JA/170GHz ● RF/170GHz ■ EU/140GHz
- ◆ JA/110GHz ■ RF/140GHz ◆ US/110GHz

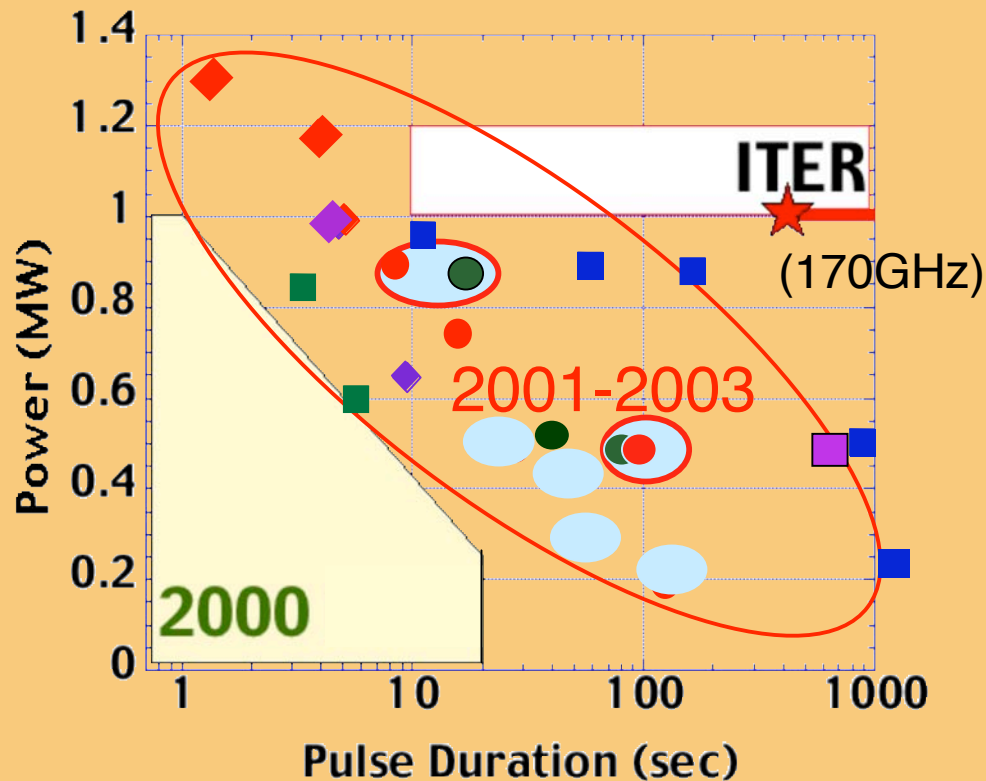

Japan

170GHz
110GHz



Russia

170GHz
140GHz



EU

140GHz

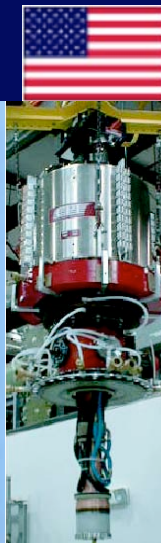

USA

110GHz
140GHz

Test of 170 GHz/1 MW in CW operation (> 400 sec) is in progress.

Test Blanket Modules (TBMs)

- **Three equatorial ports (2.2mx1.8m), shared by several concepts.**
- **Test Blanket Working Group**
 - oversees and coordinates designs of TBMs and machine interfaces;
 - promotes cooperation among participants on the associated R&D.
- **Concepts (five multi-Party working design groups established)**
 - water-cooled solid breeder;
 - helium-cooled solid breeder;
 - helium-cooled lithium-lead;
 - self-cooled liquid lithium;
 - lithium salt.
- **ITER can prove principle of designs**
 - benchmark fission reactor results;
 - confirm neutronic and breeding calculations;
 - tritium control and extraction experiments;
 - confirm thermohydraulic analysis and basic design principles;
 - first demonstration of electricity generation from fusion.

Worldwide Experimentation on ITER

Efficient Use of ITER
Involvement of Worldwide Community

ITER Site

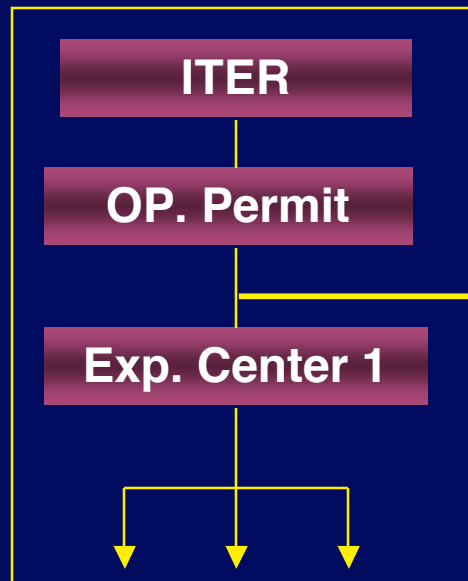

ITER Remote Experimental Site

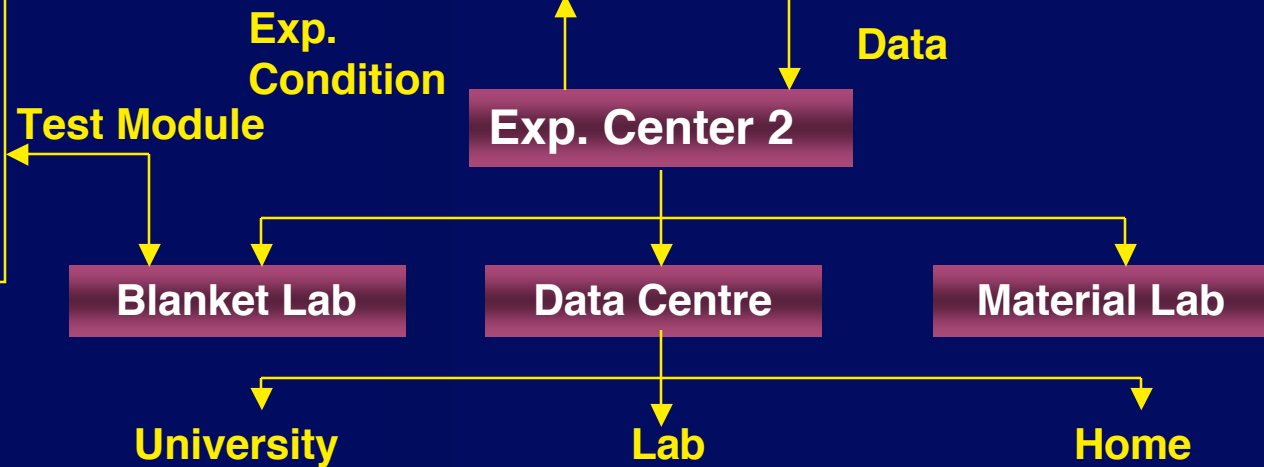

Example: 3 shift/day on site (night shift for monitoring and support of remote experiment)
1 or 2 shift(s)/day on remote experimental sites

Broadening the Scope of ITER

- **Suggested initially to resolve ITER siting problem.**
- **Includes:**
 - Remote experimental control centre as focus for interaction with ITER.
 - Virtual plasma modelling laboratory, to bring together models for plasma behaviour on ITER and to make predictions, feeding back information subsequently from ITER operation.
 - “Satellite” tokamak providing support (and ability to rapidly evaluate new ideas) during ITER construction and operation.
 - DEMO design team.
 - DEMO materials test/qualification facility (IFMIF).

Negotiations

- **Began in July 2001 with the following aims**
 - **draft Joint Implementation Agreement**
 - **agree how the procurement and costs will be shared**
 - **define how the project will be managed**
 - **select ITER construction site**
 - **identify the Director General and senior staff.**
- **Deadlocked over choice of construction site.**



← **Cadarache or Rokkasho** →



11/3/04

ITER

Construction Cost Sharing

- **EU:** TF(0.5), conductors, cassette and outer target, vac.pumps, div. RH, casks (0.5), isotope sep., IC, EC, diag.
- **JA:** TF(0.5), conductors, inner target, blanket RH, EC, diag.
- **KO:** conductors, vessel ports (0.67), blanket (0.2), assembly tools, thermal shield, T storage, AC/DC (0.65), diag.
- **CN:** magnet supports, feeders, correction coils, conductors, blanket (0.2), cryostat, gas injection, casks (0.5), HV substation, AC/DC (0.35), diag.
- **RF:** PF1, conductors, vessel ports (0.33), blanket (0.2), port limiters, flexibles, dome and PFC tests, Discharge circuits, EC, diag.
- **US:** CS(0.5), conductors, blanket (0.1), vac.pumps, pellet inj., vessel/in-vessel cooling, tok exh. proc., IC, EC, diag.

Party	Share	Total
CN/KO/RF/US	10% each	40%
JA+EU	Host: 36%+Flex Non-Host: 10%+Flex	60%

- **Fund (10%):** Feeders, Shielding, viewing, NB RH, Hot cell eq., cryodist., CODAC, installation and test, other sundry items

Host provides Buildings and Utilities.
Remaining allocation (Flex.) depends on site.

Resolving the Siting Deadlock

- **Wait - one party may in time recognise the importance, responsibility and benefit of hosting the complementary activities of the broader approach are the same as those of hosting the ITER Facility.**
 - **EU and Japan seem ready to fund the broader approach items.**
 - **The strong support to ITER and fusion, with possibly large resources, can be efficiently used to accelerate integrated magnetic fusion development.**
 - **The scientific activities can start immediately in the non-ITER-Host Party.**

Conclusions

- **The ITER Transitional Arrangements are being used at the project technical level to get many things ready that will ease the path once the negotiations are successfully completed.**
- **Further careful considerations and preparations are required, especially in the Project Organization, Staffing, Procurement System, and the relationship among the ITER International Organization, Domestic Agencies and suppliers.**
- **Agreement should leave enough flexibility for the future Project's Director General.**
- **Although negotiations on siting ITER are currently deadlocked, discussions at the necessary level have only been going on since December 2003.**
- **Today, it seems best to reinforce the Broader Approach, to recognize that hosting the complementary activities is as essential as hosting the ITER facility, and to wait and see if consensus can be achieved by the end of 2004, leading to only 1 year delay in first plasma (now 2015).**